

## Time delay relays

Time cubes®

Pulse shapers

**01** E



**New in this prospectus . . .**

• • • **Multifunctional time delay relays EC030** 6  
 New: With UC24V also suited for AC24V~ .....

• • • **Multifunctional time delay relays 16<sup>2/3</sup>Hz** 9  
 New: Type CM1, CM1L usable even from 16<sup>2/3</sup>Hz .....

• • • **Time cubes CT2, CT3** 13  
 New: Now with only 1 time range 0,2s - 30min.....

• • • **Restart delay relay** 17  
 New: Type C65, C66 with function X1 .....

• • • **Multifunctional time delay relay C56** 18  
 According to C55, but with potential free triggering.....

Delay functions

**E** On delay  

 S  $\Rightarrow$  R on with delay  
 SOFF  $\Rightarrow$  R off

**A** Off delay  

 S  $\Rightarrow$  R on  
 SOFF  $\Rightarrow$  R off with delay

**F** On and off delay  

 S  $\Rightarrow$  R on with delay (t1)  
 SOFF  $\Rightarrow$  R off with delay (t2)

Shot timing modes

**W** One shot leading edge  

 S  $\Rightarrow$  R on for t  
 SOFF  $\Rightarrow$  R off (pulse clipping)

**N** One shot trailing edge  

 SOFF  $\Rightarrow$  R on for t  
 S on for t  $\Rightarrow$  R off

**Q** One shot leading and trailing edge  

 S  $\Rightarrow$  R on for t1  
 SOFF  $\Rightarrow$  R on for t2  
 SOFF off for t1  $\Rightarrow$  R off

Pulse shaping

**K** Pulse shaping  

 S (pulse or continuous contact)  $\Rightarrow$  R on for t  
 S --- no influence on R and t

**L** Pulse shaping, retrigger. (subsequ. time operation from O)  

 S (pulse or continuous contact)  $\Rightarrow$  R on for t  
 S on for t = tRESET

**M** Pulse shaping  

 SOFF  $\Rightarrow$  R on for t  
 S --- no influence on R and t

Blinker functions

**B** Blinker, pulse start  

 S  $\Rightarrow$  R on/off periodically according to t  
 SOFF  $\Rightarrow$  R off

**B1** Blinker, pulse start, trailing pulse  

 S  $\Rightarrow$  R on/off periodically according to t  
 SOFF: last pulse = t

**B2** Blinker, interval start  

 S  $\Rightarrow$  R after t on/off periodically according to t  
 SOFF  $\Rightarrow$  R off

Delayed pulse

**G** On delay single shot  

 S (pulse or continuous contact)  $\Rightarrow$  R after t1 on for t2  
 S --- no influence on R and t

**H** On delay single shot  

 S  $\Rightarrow$  R after t1 on for t2  
 SOFF  $\Rightarrow$  R off

Repeat cycle timer

**I** Repeat cycle timer, pulse start  

 S  $\Rightarrow$  R on/off periodically according to t1 and t2  
 SOFF  $\Rightarrow$  R off

**P** Repeat cycle timer, interval start **C55, CT1: t2 t1**  

 S  $\Rightarrow$  R after t1 (t2) on/off periodically according to t2 and t1  
 SOFF  $\Rightarrow$  R off

Special functions

**Y** Star-delta timer  

 S  $\Rightarrow$   $\Delta$  on for t  
 $\Delta$  OFF  $\Rightarrow$   $\Delta$  on with delay for t-delta  
 SOFF  $\Rightarrow$   $\Delta$  off

**X1** Restart delay  

 S  $\Rightarrow$  R on.  
 SOFF  $\Rightarrow$  R off and starts t.  
 S  $\Rightarrow$  R restart only after t.

Stop/Reset

<b>tSTOP</b> S <sub>STOP</sub> interrupts t (t-addition)	<b>T</b> t is stopped $\Rightarrow$ R on/off
<b>tRESET</b> S <sub>RESET</sub> resets t t restarts immediately	<b>T</b> Test



S = Triggering  
 R = Output circuit  
 $\Rightarrow$  = switches...

Pulse sequence monitoring

**U** 
 S1/S2  
 P(tp)  
 R

**V** 
 S1/S2  
 P(tp)  
 R

S1/S2 = Monitoring start  
 P = Pulse sequence  
 tp = Pulse separation

$\leq$ : Pulse separation is smaller than the time tp  
 $>$ : Pulse separation is larger than the time tp

Start with S1 = without start-up short-out tA  
 Start with S2 = with start-up short-out tA

tv = settable alarm delay (tA = tv)



DIN time delay relays (1 function)

C13 13

DIN A 17,5

△-△  
DIN C

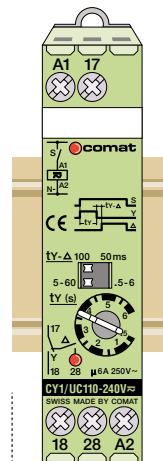
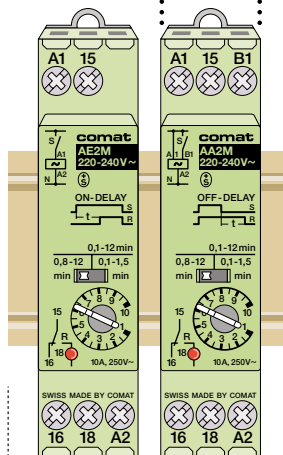
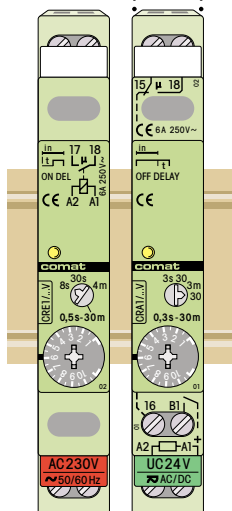
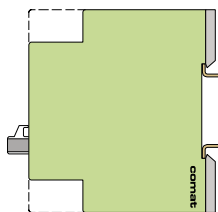

Economy time delay relays

Only 13 or 17,5mm wide. Ideal for applications with a fixed function E, A or Y. Suited for snap-on installation in accordance with DIN 43880.

CRE1

Economy time delay relay on delay, voltage controlled, LED for R.

CRA1

Economy time delay relay off delay, voltage controlled, LED for R.

AE2  
AE2M

Economy time delay relay on delay, voltage controlled. 1 changeover contact. Output-LED.

AA2  
AA2M

Economy time delay relay off delay, voltage controlled. 1 changeover contact. Output-LED.

CY1

Star-delta time delay relay with adjustable △-△ interval. Safety locking of the △ output.

**E-0** Triggering  
Function → page 3

**E-0**      **A-2**

**E-0**      **A-2**

**Y-0**

Time range  
\* TF60 setting → page 4

0,5-8s...  
2-30min      0,3-3s...  
3-30min \*

AE2 0,8s-1,5m      AA2 0,8s-1,5m  
AE2M 0,1-12min      AA2M 0,1-12min

t<sub>△</sub> 0,5-60s  
t<sub>△-△</sub> 50/100ms

Triggering

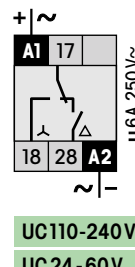
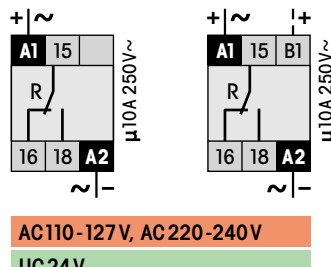
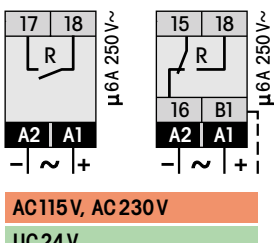
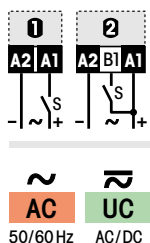

Ordering no. →

CRE1 / ... V      CRA1 / ... V

AE2 / ... V      AA2 / ... V  
AE2M / ... V      AA2M / ... V

CY1 / ... V

Example of order:  
Time delay relay CRE1/AC230V

Example of order:  
Time delay relay AE2/UC24V

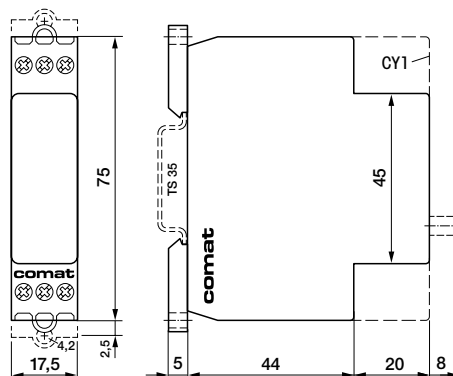
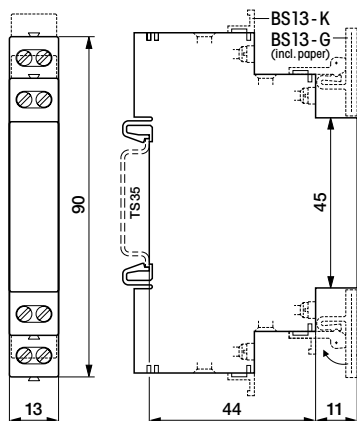

# Multifunctional time delay relays

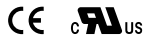
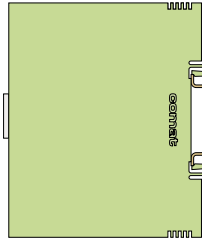

Multifunctional time delay relays  
22,5 mm  
for timing functions from 0,1s up to 12 hours.

**E** 1 Triggering  
Function → page 3

Time range  
★ TF60 setting → page 4

Triggering

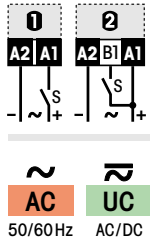

Ordering no. →

**comat**

## Multifunctional time delay relays

**ECO30**

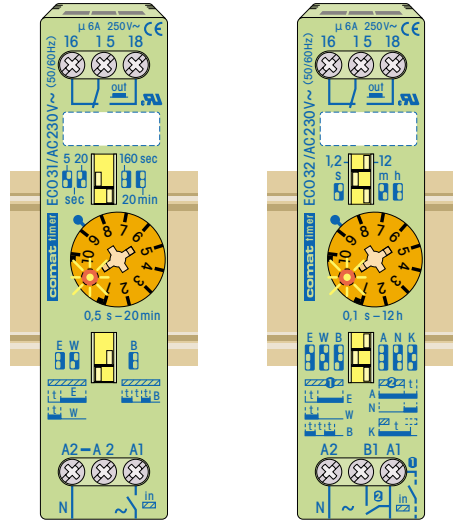

**ECO31**

Economy time delay and blinker relay  
3 functions, voltage controlled.  
LED for R.

**E W B** 1

0,5 s - 20 min  
0,5-5s...2-20 min

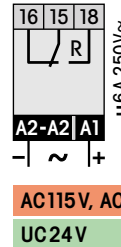

ECO31 / ... V

**ECO32**

Multifunctional time delay relay  
2 delay functions, 2 shot timing modes, blinker pulse shaping K.  
LED for R.

**E W B** 1  
**A K N** 2

0,1 s - 12 h ★  
0,1-1,2s...1-12 h

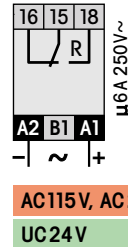

ECO32 / ... V

Example of order:  
comat timer ECO32/AC230V

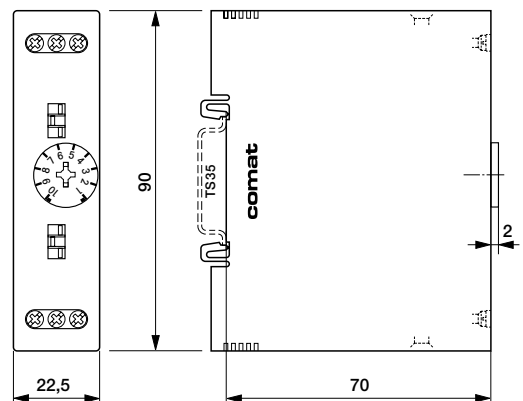

Multifunctional time delay relays

C13

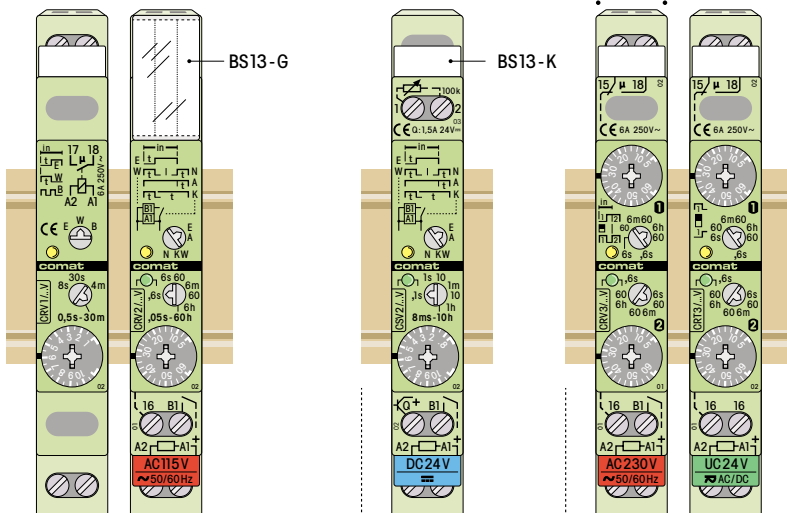
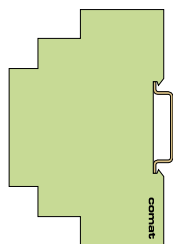

13

**Ultra-narrow 13 mm time delay relay system**  
for all timing functions from 50ms up to 60 hours. With only 13mm fitting width especially suited for use in the industrial interface sector.

**E 1** Triggering  
Function → page 3

**Time range**  
★ TF60 setting → page 4

**Triggering**

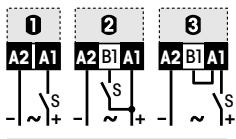

AC 50/60Hz UC AC/DC DC 10%

Ordering no. →

**CRV1**

**Economy time delay and blinker relay**  
3 functions, voltage controlled. LED for R.

**E W B 1**

0,5 - 8s...  
2 - 30min



AC115V, AC230V  
UC24V

CRV1 / ...V

**CRV2**

**Universal multifunctional time delay relay**  
2 delay functions, 2 shot timing modes, pulse shaping K. LED for B1 + R.

**E W 3**  
**A K N 2**

50 - 600ms...  
5 - 60h \*

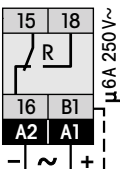

AC115V, AC230V  
UC24V

CRV2 / ...V

**CSV2**

**Multifunctional time delay relay**  
like CRV2, but with solid-state output and connection for remote potentiometer.

**E W 3**  
**A K N 2**

8 - 100ms...  
0,8 - 10h \*

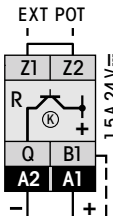

DC24V

CSV2 / ...V

**CRV3**

**Double time delay relay**  
F (E and A) or Q (W and N). t1/t2 separately settable. LED for B1 + R.

**F Q 2**

t1: 50 - 600ms...5 - 60h \*  
t2: 50 - 600ms...5 - 60h \*

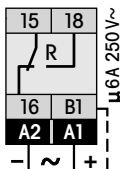

AC115V, AC230V  
UC24V

CRV3 / ...V

**CRT3**

**Universal repeat cycle timer**  
Pulse or pause start. t1/t2 separately settable. LED for A1 + R.

**I P 1**

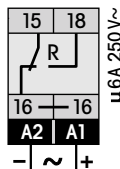

AC115V, AC230V  
UC24V

CRT3 / ...V

Example of order:  
Time delay relay CRV2/AC230V

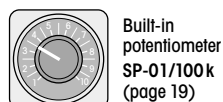
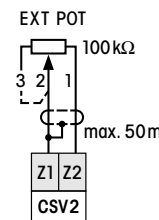
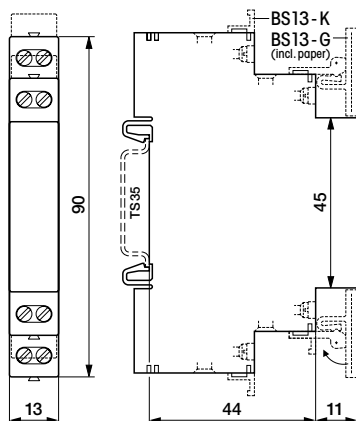

Built-in potentiometer SP-01/100k (page 19)

Multifunctional time delay relays

DIN A

17,5

Multifunctional time delay relays

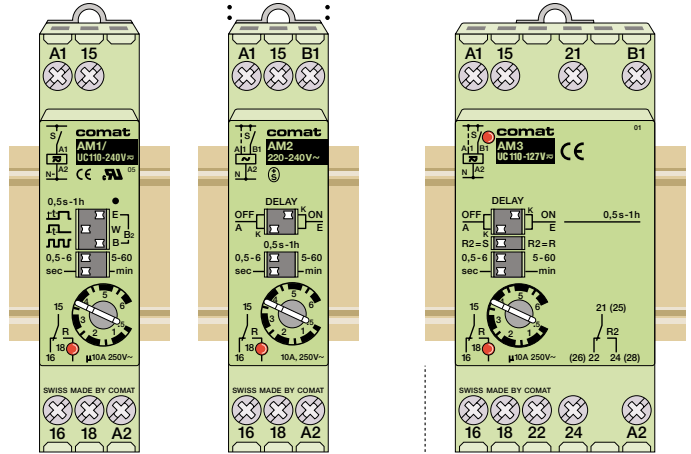
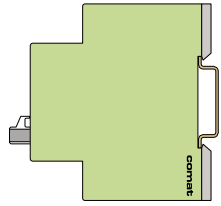

17,5mm time delay relay system in compact design. Suited for snap-on installation in accordance with DIN 43 880.

**E** **0** Triggering  
Function → page 3

Time range  
Partial ranges

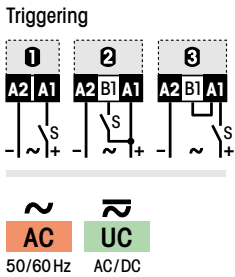

Ordering no. →

AM1

Economy time delay and blinker relay on delay, one shot leading edge. 2 blinker functions. Output-LED.

**E** **W** **B** **B2** **0**

0,5 s - 60 min  
0,5 - 6s...5 - 60 min

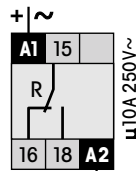

UC110-240V  
UC24-60V

AM1 / ... V

AM2

Universal time delay relay on delay, off delay, one shot leading edge, pulse shaping K, voltage controlled. Output-LED.

**E** **23**  
**A** **K** **2** **W** **3**

0,5 s - 60 min  
0,5 - 6s...5 - 60 min

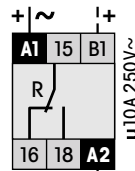

AC220-240V  
AC110-127V  
UC24-60V

AM2 / ... V

AM3

Universal time delay relay with instantaneous contact or both contacts delayed (programmable). Functions like type AM2. Display of control input B1 (S) in addition to the output-LED.

**E** **23**  
**A** **K** **2** **W** **3**

0,5 s - 60 min  
0,5 - 6s...5 - 60 min

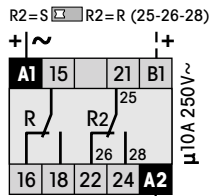

AC220-240V  
UC24-60V, UC110-127V

AM3 / ... V

Example of order:  
Time delay relay AM2/UC24-60V

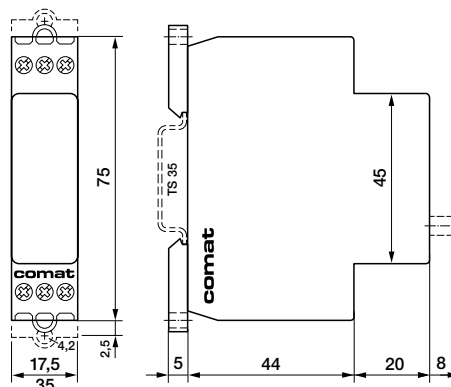

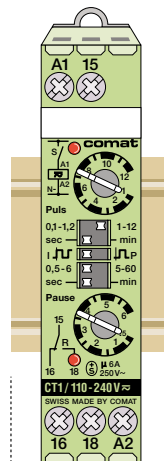
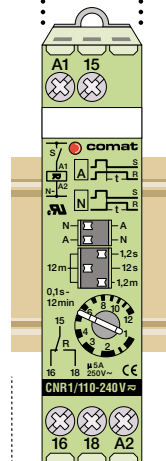
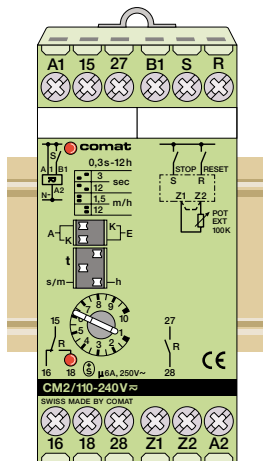
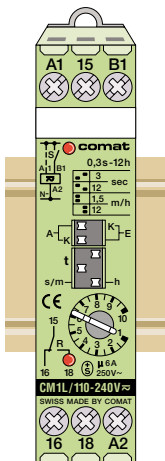
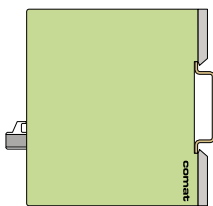

17,5 mm time delay relay system in compact design. (For snap-on installation in accordance with DIN 43 880, see series DINA and C13.)

**E 1** Triggering  
Function → page 3

Time range  
Partial ranges

Triggering

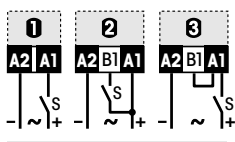

**UC**  
AC/DC

Ordering no. →

**CM1  
CM1L**

Universal time delay relay on delay, off delay, one shot leading edge, pulse shaping K, voltage controlled, LED for B1 and R.

**E 2 3**  
**A K 2 W 3**

CM1 50 ms-100 m  
CM1L 0,3 s-12 h

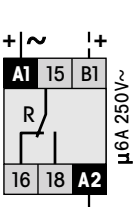

**UC110-240V** 16 18 A2 250V~  
**UC24-60V**

CM1 / ...V  
CM1L / ...V

**CM2**

Universal time delay relay like type CM1, but with time stop and reset input as well as connection for remote potentiometer 100k. 2 heavy current contacts.

**E 2 3**  
**A K 2 W 3**

0,3 s-12 h  
0,3-3 s...1,2-12 h

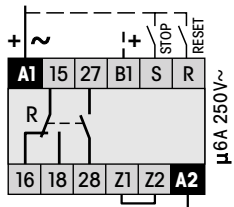

**UC110-240V**  
**UC24-60V**

CM2 / ...V

**CNR1**

Time delay relay, no auxiliary voltage. Function runs after cut off power supply. Minimum triggering time 150 ms only.

**A N 1**  
no auxiliary voltage

0,1-1,2 s...  
1-12 min

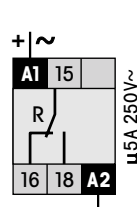

**UC110-240V**  
**UC24-60V**

CNR1 / ...V

**CT1  
CT1L**

Universal repeat cycle timer pulse or pause start, t1/t2 separately settable. LED for A1 and R.

**I P 1**

CT1 t1 0,1 s-12 m  
t2 0,5 s-60 m  
CT1L t1 0,5 s-60 m  
t2 0,3 m-30 h

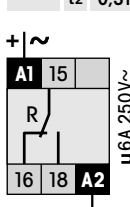

**UC110-240V**  
**UC24-60V**

CT1 / ...V  
CT1L / ...V

Example of order:  
Time delay relay CM2 / UC110-240V

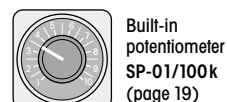
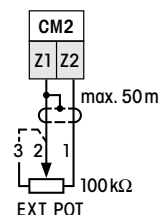
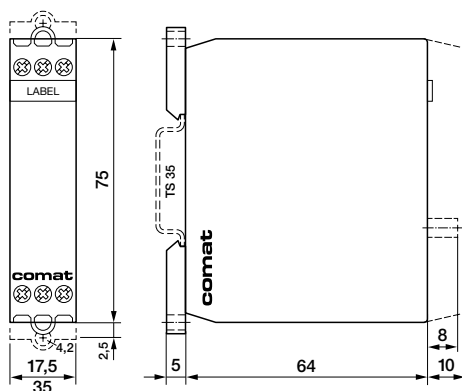

Built-in potentiometer SP-01/100k (page 19)

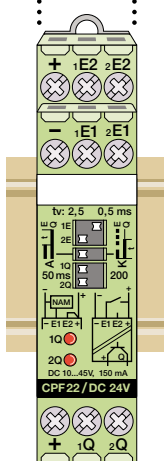
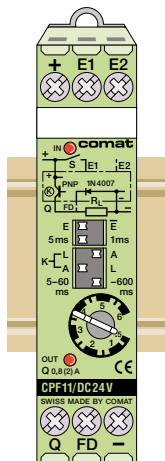
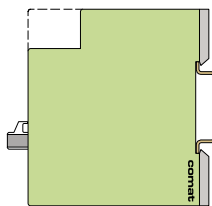

CPF11

Single channel pulse shaper

- Input reversible (E-E)
- Input and output times separately settable
- 3 (6) functions to choose
- Additional free wheel diode 1A
- LED display for E and Q

Function → page 3



Settable times:  
input pulse ≥ 1/5 ms      output pulse 5 ÷ 600 ms

CPF22

Double channel pulse shaper

- Input/output galvanically isolated 4kV
- Input and output times separately settable
- 2 functions to choose
- LED output display for each channel

Function → page 3



Settable times:  
input pulse ≥ 0,5/2,5 ms      output pulse 50/200 ms

CPF pulse shapers

with the firing functions K, L and A are specialist devices for the lengthening or the limitation of control pulses.

In this fully electronic design with the facility for also connecting NAMUR sensors they are the ideal interface modules in modern control systems.

Always there where fast processes, high rotations, i.e. the briefest pulses, are to be evaluated, the cost-effective solution is:

CPF Pulse shapers.

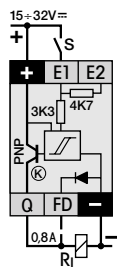
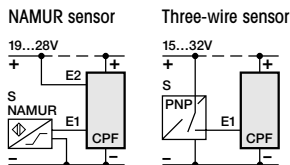

DC 24V  
CPF11 / ...V

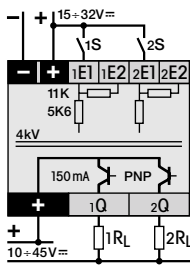

DC 24V  
CPF22 / ...V

DC 10%

Ordering no. →

Example of order:  
Pulse shaper CPF11/DC24V

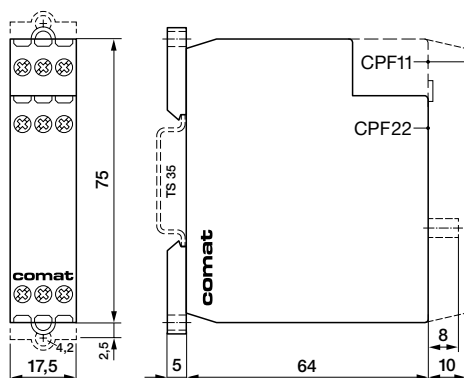

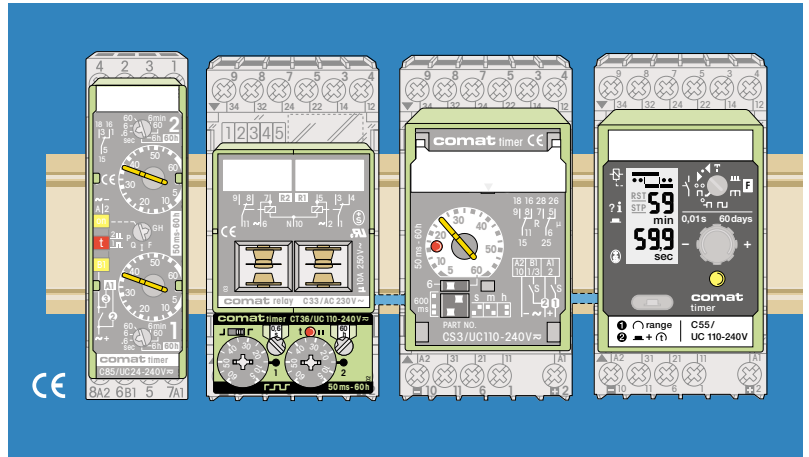

# Plug-in Time delay relays Time cubes®

**C80 CT.. CS.. C60 C50**

This issue replaces all previous issues. Availability, errors and specifications subject to change without notice.

Multifunctional time delay relays

C80

22,5

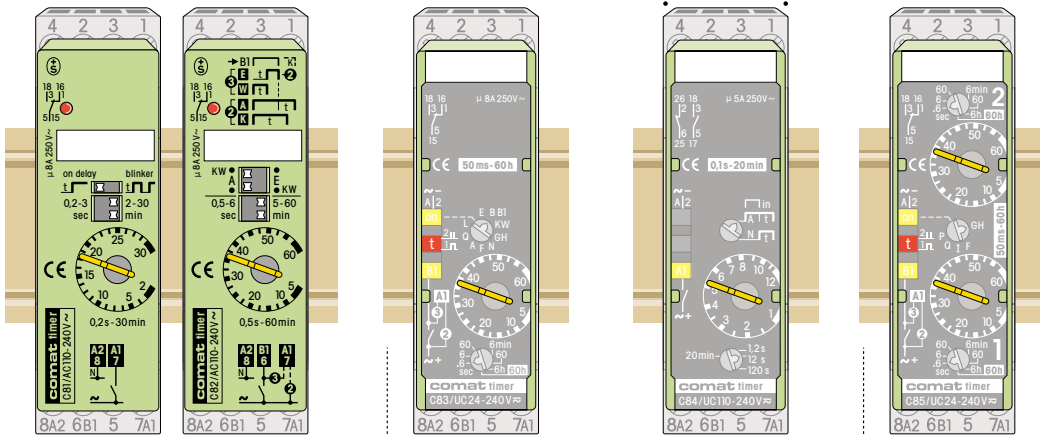
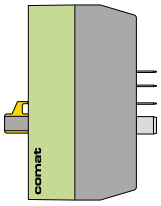

22.5mm plug-in time delay relay system for all delay, shot timing and blinking functions. Double functions, repeat cycle timing and functions without auxiliary voltage.

C81

**Economy time delay relay** on delay or blinking, voltage controlled, output-LED.

E B2 0

0,2s - 30min  
0,2-3s...2-30min

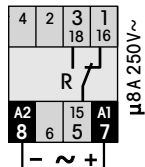

AC110-240V  
UC 24-48V

C81 / ...V

C82

**Economy time delay relay** on delay, off delay, one shot leading edge, pulse shaping K, voltage controlled, output-LED.

E 23  
A K 2 W 3

0,5s - 60min  
0,5-6s...5-60min

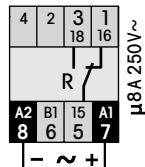

AC115V, AC230V  
UC24V, UC24-240V

C82 / ...V

C83

**Universal multifunctional time delay relay** • 12 functions + ON (Test), voltage controlled. • Time lapse display (double blinking=t2) • Input-LED (24-240V) • Output-LED

E 23 W H B 3 2  
A N L F K G B1 Q

50ms - 60h\*  
50-600ms...5-60h

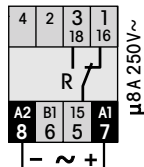

AC115V, AC230V  
UC24V, UC24-240V

C83 / ...V

C84

**Time delay relay, no auxiliary voltage** • Off delay • One shot trailing edge • Triggering display • Minimum triggering time 150ms only

A N 0

0,1s - 20min  
0,1-1,2s...1,7-20min

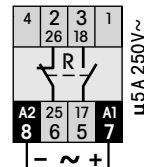

UC24-48V  
UC110-240V

C84 / ...V

C85

**Double time delay relay and repeat cycle timer** • 6 functions + test • t1/t2 separately settable • Time lapse display (double blinking=t2) • Input-LED (24-240V) • Output-LED

I P 23  
F Q G 2 H 3

2x 50ms - 60h\*  
2 x 50-600ms...5-60h

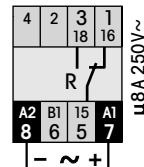

AC115V, AC230V  
UC24V, UC24-240V

C85 / ...V

E 0 Triggering  
Function → page 3

Time range  
\* TF60 setting → page 4

Triggering

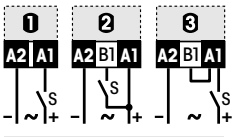

AC UC  
50/60Hz AC/DC

Ordering no. →

Example of order:  
Time delay relay C83/UC24-240V  
System socket CS-18

F Q G H  
t2=t1 t2=0,5s

System socket CS-18  
Figure: with inserted retaining clips (standard delivery)

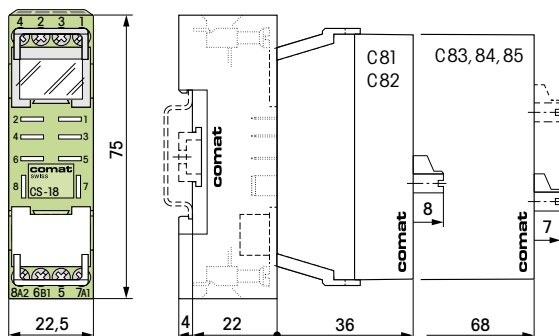

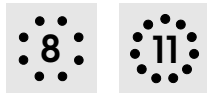

Plug-in time cubes

CT2 CT3

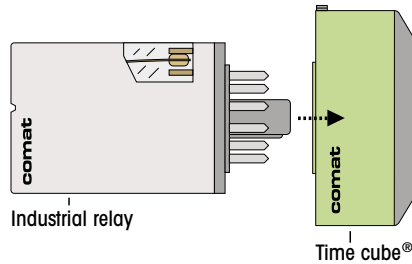

CE cULus

0,2 s-30 min  
0,2-3s/min • 2-30s/min

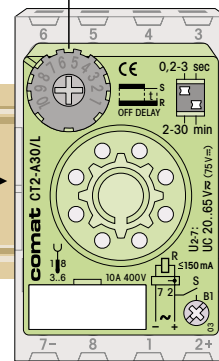

0,2 s-30 min  
0,2-3s/min • 2-30s/min

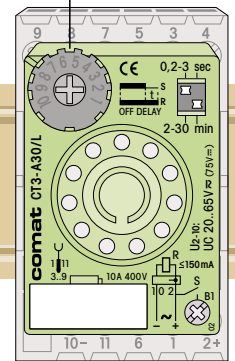

8-/11-pole plug-in time delay relay system

The simplest time delay relay system world-wide, fitting all 8 or 11-pin relay sockets (octal/sub-magnalite). Original time cubes® are simply placed between socket and relay without rewiring. In this way, even as a retrofit, all

industrial relays can be provided with the required timing functions without additional space being required. The contact connections of the relay on the socket remain through-connected.

All new types ..30 (0,2s-30min) are fully compatible with all previous types ..20, ..21 and ..25.

CT2 (8-pin)

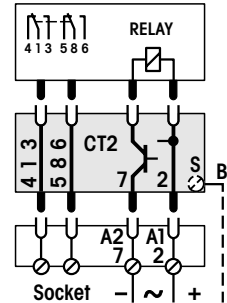

CT3 (11-pin)

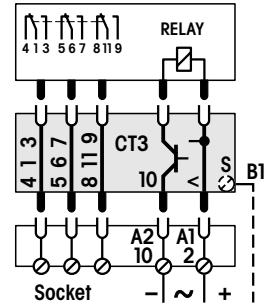

Triggering

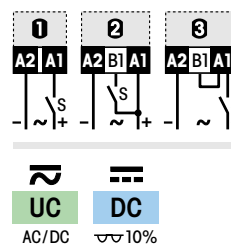

Function → page 3	Order no.	UC180-265V	UC90-150V	UC90-265V	UC20-65V	DC9,5-18V
Trigging 2 = 8-pole	CT...-E30/...	H	L	S		
Trigging 3 = 11-pole	CT...-A30/...	U	M	L	S	
	CT...-K30/...	U	M	L	S	
	CT...-W30/...	H	L	S		
	CT...-B30/...	H	L	S		

Example of order:  
Time cube CT3-E30/H  
Socket EC-11  
Relay 11-pole  
(→ prospectus "Industrial relays")

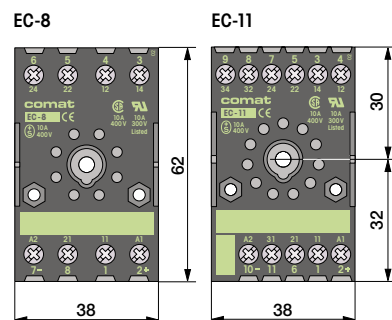
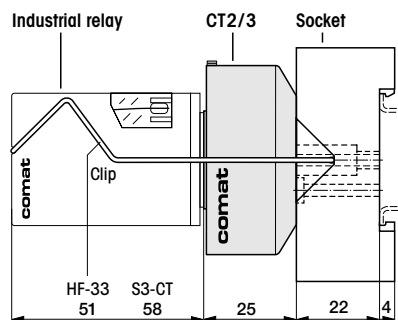

Multifunction time delay relays, modular

CT

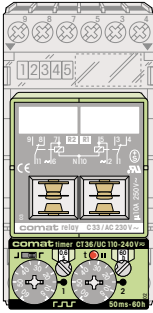

The Comat CT System is modular.

The time delay relays and monitoring relays consist of the plug-in CT electronic module and an 11-pole CT output relay. Both system components can be combined freely with one another. This allows the equipment to be selected optimally for specific use.

Subsequent modifications, for example a change from mechanical contacts to solid-state outputs, are possible at any time by simple reconnection.

This provides the user a complete, universal system, the high flexibility of which is unique throughout the world.

The system socket C12B0 serves as a basis for the vibration-free reception of the electronic module. It has a 4-pole module slot in which the CT-module –also without output relay– locks in such a way that it is vibration-free. Contact is via twin knife contacts which ensure optimal contact reliability.

With the A2-connector C-A2 plug-in flush in the socket, the neutral conductor (N / -) can be connected as a 10A bus from socket to socket. This considerably reduces wiring work.

Robust terminals for cross-sections up to 4mm<sup>2</sup> and generous labelling facilities are other advantages of this practical comat system socket. As variants to the standard socket C12B0, two identical sockets, but with printed device diagram, are available (C12B1/2). By clearly identifying the connections, these sockets ensure rapid, error-free and therefore economical wiring. When a service is required, they facilitate fault location.

The CT module demonstrates comat's practical experience in the area of industrial electronics. All control and display elements are arranged on the front and are labelled in a self-explanatory manner for international use. The values set are also clearly legible when the module has been installed.

Printed diagrams explain the functions, and the connection scheme directly indicates the appropriate terminals in the system socket.

A transparent front cover provides protection from unauthorized misadjustment and additionally locks the module onto the output relay.

Triggering is performed with the operating voltage (L1 or +). Hence, no potential-free contacts are required. Triggering complies with the machine standards. A parallel connection of other users to B1 is admissible.

The 2 voltage ranges UC110-240V and UC24-48V have been chosen by comat to ensure a high level of reliability in triggering. They permit use with an AC or DC supply and optimal adaptation to the operating conditions of modern controls.

In case of an even broader voltage range, e.g. 24-240V it is often possible to achieve only currents of a few 100 µA in the trigger circuit B1 with simultaneous low threshold voltages to less than 20V. This may lead to unintentional triggering due to capacitive/inductive pickups, or faulty switching may occur owing to sufficiently loaded control contacts. During operation, 50V are readily measured on open-ended lines.

The consumption of the CT modules comes to less than 1W.

The output relays have the complete device diagram, the performance data and the complete order no. on the front, supported by a colour code, which indicates an AC coil with red and a DC coil with blue. The .1 and .2 relays have a safety manual operation facility as a standard feature, which switches the contacts only after a lock has been released (two-hand principle).

The standard contacts .1 and .3 have proved their worth millions of times in heavy current applications. The contact material AgNi permits a large switching range and thanks to generous dimensioning achieves a high number of cycles. With its high breaking capacity of up to 10A/400V, this contact is a reliable allround contact for use both in mains circuits and in the lower voltage range from 12V/10mA.

The twin contacts .2 and .4 switch every circuit with two independent reeds. Compared with single contacts, they provide up to 100 times greater safety with regard to the level of possible faulty switchings. In spite of their high breaking capacity of up to 6A/250V, these contacts are particularly suitable for low switching currents and switching voltages down to 1mA/6V.

The solid-state relays are used instead of mechanical contacts. In the standard version .5, the relay has a potential-free output which switches an AC or DC load in the same way as a mechanical contact. However, it functions without bounce or wear, withstands overloads, has short-circuit protection and has a practically unlimited life even with full output load.

Preferred applications are high switching frequency, for example as repeat cycle timers, flashing bars with bulb load or extreme inductive loads, for example large solenoid valves, couplings, motors, etc.

An additional protective wiring of the output or of the load is not necessary in these comat relays for any application.

They are completely insensitive in an aggressive atmosphere, for example in the chemical industry, in waste water treatment plants, etc.

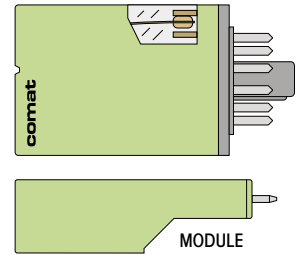

Triggering

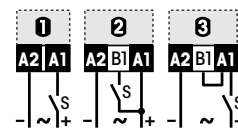

Timer module	Function/triggering	Time range
<b>CT30</b> Economy timer 3 functions, voltage controlled, output LED.	E W B ①	0,25s-30 min 0,25-3s... 2,5-30 min
<b>CT32</b> Universal timer 7 functions, voltage controlled, time lapse display, blinking.	E ② ③ A N K B1 ② W B ③	0,15s-60 min 0,15-1,5s... 6-60 min *
<b>CT33</b> Universal timer 12 functions, voltage controlled, time lapse display, blinking, high setting accuracy by dial graduation 1:5.	E ② ③ A N L F K G B1 Q W H B ③	30ms-60h 30-150ms... 12-60h *
<b>CT36</b> Universal repeat cycle timer Pulse or pause start. t1/t2 separately settable. Time lapse display t1/t2.	I P ①	2x 50ms-60h 2x 50-600ms... 5-60h *

F Q G H  
t2 = t1 t2 = 0,5s

\* TF60 setting  
→ page 3

Note on use

According to the standards «Safety of machines» e.g. EN 60204-1, EN 292-2, triggering with A2-potential (N/-) is only admissible in exceptional circumstances.

For that reason the comat CT modules are triggered by A1-potential (L/+).

This makes them unrestrictedly suitable also for use in machines and systems which must conform with machine or CE guidelines or directives.

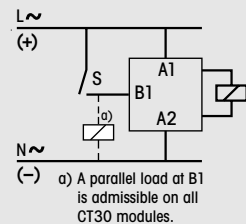

Order no. for individual module (without output relay):

UC110-240V	UC115V, UC230V	UC115V, UC230V	UC110-240V
UC24-48V	UC24-48V	UC24-48V	UC24-48V
CT30 / ..V	CT32 / ..V	CT33 / ..V	CT36 / ..V

Time delay relay assembled (module + output relay)

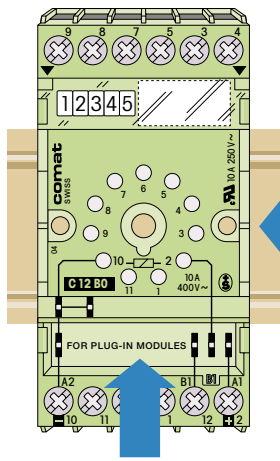

Contact outputs

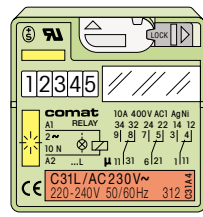

**.1**  
3 changeover contacts  
10A 400V~ 1)

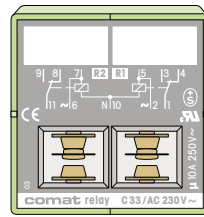
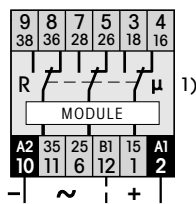

**.3**  
2x1 changeover contacts  
(with instantan. contact)  
10A 250V~ 2)

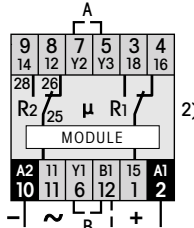

Solid-state outputs

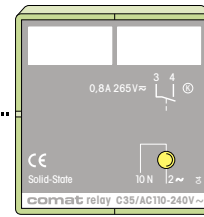

**.5**  
Solid-state output  
for AC or DC load  
0,8A 10-265V~

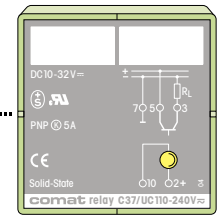
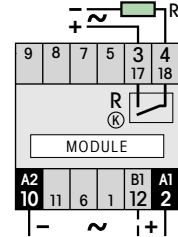

**.7**  
Solid-state output  
for DC load  
5A 10-30V~

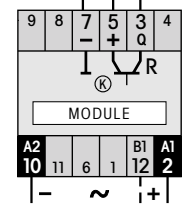

MODULE

Order no. for module + outup relay (delivery unit):

AC 24, 48, 115, 230V	AC 24, 48, 115, 230V
DC 24, 48, 110, 220V	DC 24, 48, 110V
Order no. → CT30.1 / ... V	Order no. → CT30.3 / ... V

Order no. for module + outup relay (delivery unit):

AC 110-240V	UC 110-240V
UC 24-48V	UC 24-48V
Order no. → CT30.5 / ... V	Order no. → CT30.7 / ... V

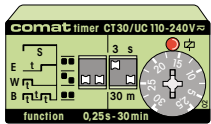

Order no. →

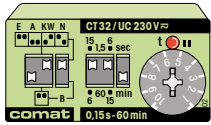

Order no. →

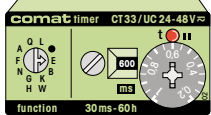

Order no. →

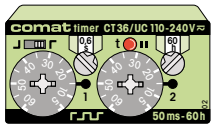

Order no. →

Example of order:  
Timer CT32.1/AC 230V  
System socket C12 B0

A Jumper 5-7 : R2 = R1  
B Jumper 6-12 : R2 = S

AC 50/60Hz UC AC/DC DC 10%

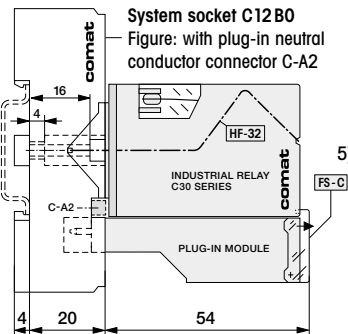
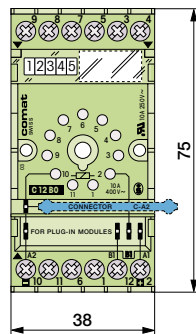

Order no. for individual output relay (without module):

AC 24, 48, 115, 230V	AC 24, 48, 115, 230V	AC 110-240V	UC 110-240V
DC 24, 48, 110, 220V	DC 24, 48, 110, 220V	UC 24-48V	UC 24-48V
C31 / ... V <sup>3)</sup>	C31L / ... V <sup>4)</sup>	C35 / ... V	C37 / ... V

- 1) Same relay, but with twin contacts 6A 250V~ order no. CT...2/... V
- 2) Same relay, but with twin contacts 5A 250V~ order no. CT...4/... V
- 3) To module CT30 (without output LED)
- 4) To module CT32+36 (L=with output LED)
- 5) For relay made by Releco (instead of C31/32, or CT...1/.2): Retaining clip S3-C Front cover FS-R

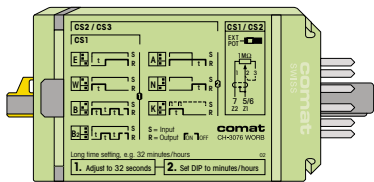

Dimensions, accessories → page 19

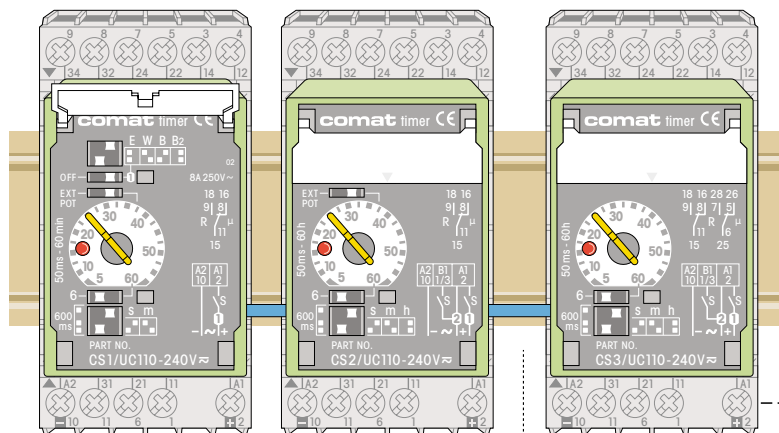

**11-pole plug-in time delay relay system** for all delay, shot timing and blinking functions from 50ms up to 60 hours. CS1, CS2 with connection for remote potentiometer. Front panel mounting with FZ-50.

**CS1**

**Economy time delay and blinker relay**  
With additional connection for remote potentiometer SP-01/1M (up to 50m).

Replaces fully compatible CSE2, CSB2

**CS2**

**Universal multifunctional time delay relay** like CS1, but with 7 functions and delay times up to 60 hours.

Replaces fully compatible CSA2, CSK2, CSN2

**CS3** (2nd contact: 6-5-7)

**Universal multifunctional time delay relay** like CS2, but with 2nd contact instead of Z1-Z2 (terminal 6-5-7).

Replaces fully compatible CSE3, CSA3

**C63** (2nd contact: 1-4-3)

**Universal multifunctional time delay relay** like CS3, but with 2nd contact on terminal 1-4-3.

Replaces fully compatible CX35, CX36

**E** 1 **Triggering**  
Function → page 3

**Time range**  
★ TF60 setting → page 4

**Triggering**

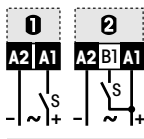

**UC**  
AC/DC

Ordering no. →

**E W B B2** 0

**50 ms - 60 min** ★  
50-600ms...5-60min

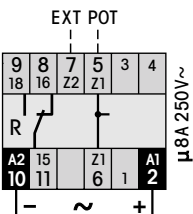

**UC110-240V**  
**UC24-60V**

CS1 / ... V

**E W B B2** 0  
**A K N** 2

**50 ms - 60 h** ★  
50-600ms...5-60h

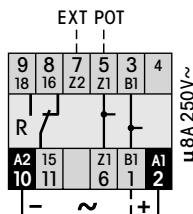

**UC110-240V**  
**UC12-15V, UC24-60V**

CS2 / ... V

**E W B B2** 0  
**A K N** 2

**50 ms - 60 h** ★  
50-600ms...5-60h

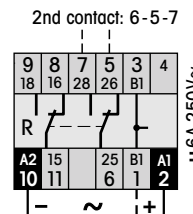

**UC110-240V**  
**UC12-15V, UC24-60V**

CS3 / ... V

**E W B B2** 0  
**A K N** 2

**50 ms - 60 h** ★  
50-600ms...5-60h

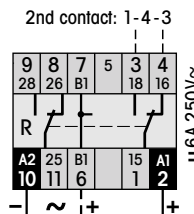

**UC110-240V**  
**UC12-15V, UC24-60V**

C63 / ... V

Example of order:  
Time delay relay CS2/UC110-240V  
System socket C11A

**System socket C11A**  
Figure: with plug-in neutral conductor connector C-A2 (standard delivery).

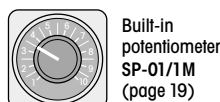
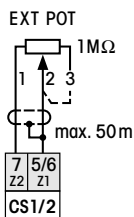
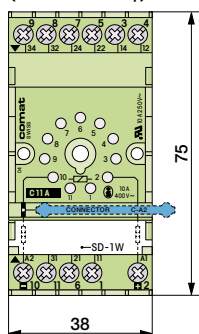

Built-in potentiometer SP-01/1M (page 19)

Restart delay relay

C65 C66

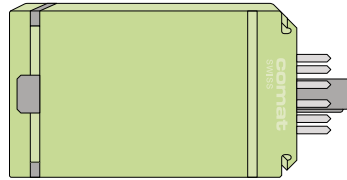
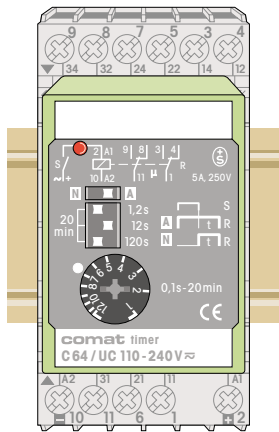

Dimensions, accessories → page 19

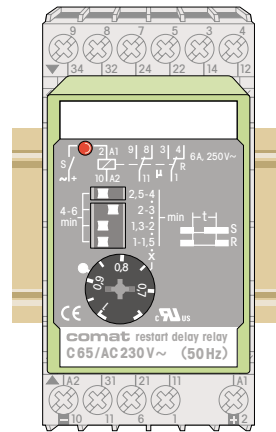
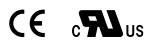

C64

Time delay relay without auxiliary voltage

True off delay or one shot trailing edge after cut off power supply. Minimum triggering time 150ms only.

Replaces RS124, CSR2

A N 0

without auxiliary voltage

0,1s-20min  
0,1-1,2s...1,7-20min

Do not connect 5-6-7!

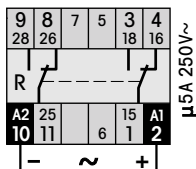

UC110-240V

UC24-60V

C64 / ...V

Example of order:  
Time delay relay C64/UC110-240V  
System socket C11A

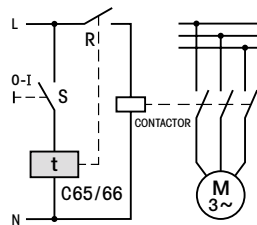

Function → page 3

0 Triggering

Time range  
Partial ranges

Triggering

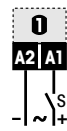

Ordering no. →

C65 (50Hz) C66 (60Hz)

Restart delay relay

The C65 (50Hz) and C66 (60Hz) are special timers with no auxiliary voltage to guarantee a minimum OFF time after removal of supply. After the interruption of supply, the device will not reclose before the set time (1-6 mins.) has elapsed, even if there has been a new command to switch ON. Typical application: After a mains failure it is not possible to restart (close contacts) before the machine is at rest. Example: Motor (see diagram on the left).

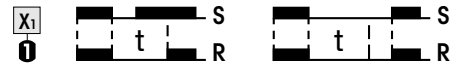

1-6 min  
1-1,5 ... 4-6 min

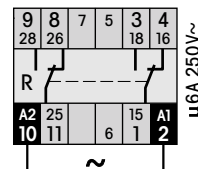

~ 50Hz

AC115V, AC230V

C65 / ...V

~ 60Hz

AC115V, AC230V

C66 / ...V

Example of order:  
Time delay relay C65/UC110-240V  
System socket C11A

System socket C11A  
Figure: with plug-in neutral conductor connector C-A2 (standard delivery).

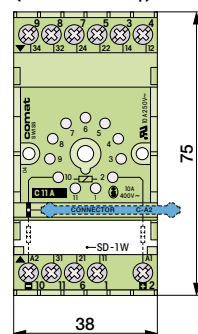

C50

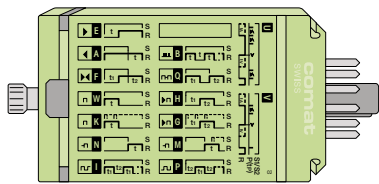

Dimensions, accessories → page 19

CE (C53, C55, C56)

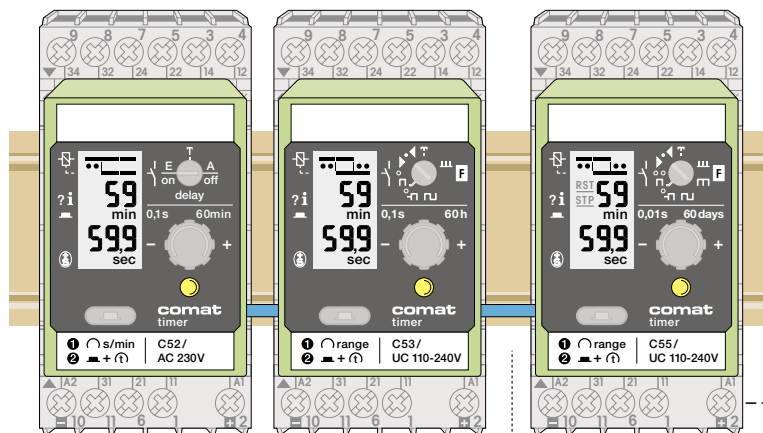

**11-pole plug-in time delay relay system** for all timing modes from 10ms up to 60 days. Extremely accurate owing to quartz time base. Digital functions and residual time display. Front panel mounting with FZ-50. Test function  $\nabla$ .

**E** Triggering  
Function → page 3

**Time range**  
Partial ranges

Triggering C52, C53, C55

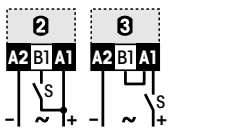

AC 50/60Hz UC AC/DC DC  $\nabla$  10%

Ordering no.

**C52**

**Universal multifunctional time delay relay**

- 2 functions
- 0.1s-60min (quartz)
- 1 power changeover contact

**E**

0,1s-60min

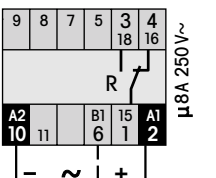

AC110-120V, AC230V  
UC24V

C52 / ...V

**C53**

**Universal multifunctional time delay relay**

- 10 functions
- 0.1s-60h (quartz)
- 1 power changeover contact
- Alternatively solid-state output .3 or .4

**E W H B I**

0,1s-60h  
0,1s-60min...0,1min-60h

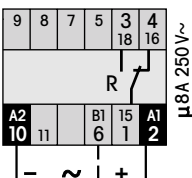

UC110-240V  
UC24-60V

C53 / ...V

**C55**

**Universal multifunctional time delay relay**

- 15 functions including U / V
- 0.01s-60 days (quartz)
- Setting step up to 60s : 1ms
- Time STOP and RESET input
- 2 changeover contacts
- Alternatively solid-state output .3 or .4

**E W H B I P**

0,01s-60days  
0,01-60s...0,1h-60days

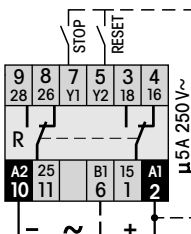

UC110-240V  
UC24-60V

C55 / ...V

**C56**

**Universal multifunctional time delay relay** like type C55, but with potential free triggering of START, STOP and RESET (insulation from 2-10: 2kV).

**E W H B I P**

0,01s-60days  
0,01-60s...0,1h-60days

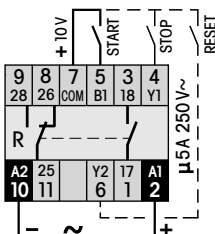

UC110-240V  
UC24-60V

C56 / ...V

Example of order:  
Time delay relay C53/UC110-240V  
System socket C11A

System socket C11A  
Figure: with plug-in neutral conductor connector C-A2 (standard delivery).

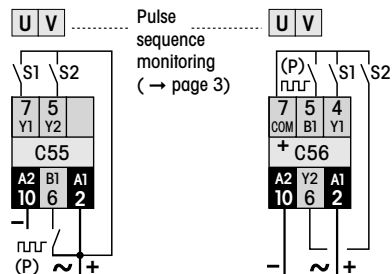
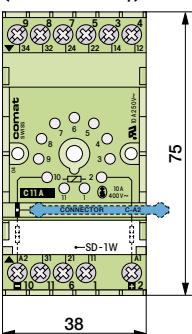

Accessories for the series CS, C50, C60  
DIN-rail or screw mounting

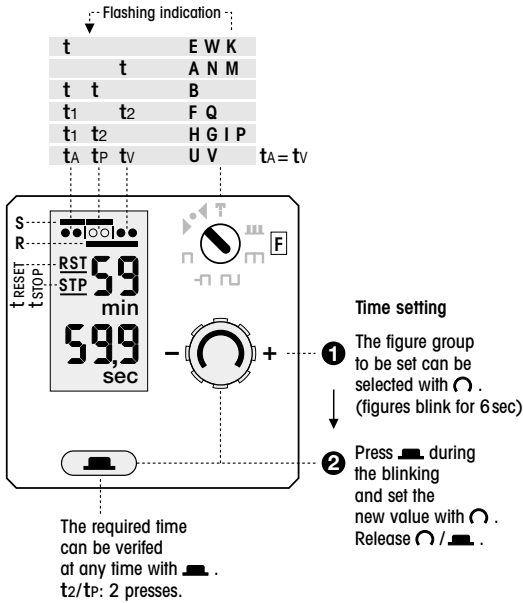

Solid-state output for C53, C55 (instead of contact)

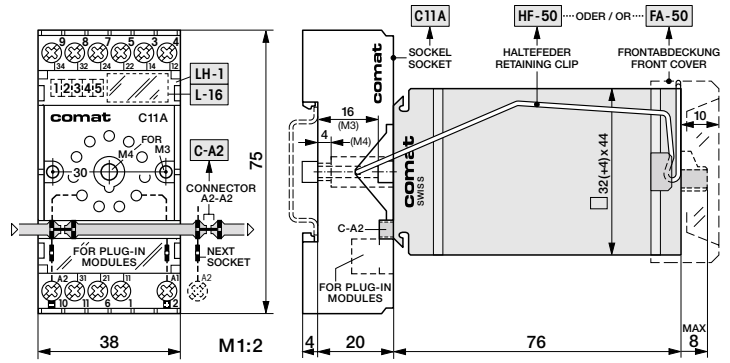
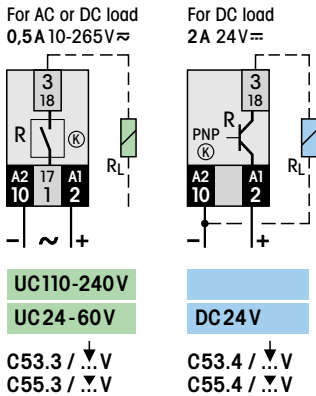

Front panel mounting

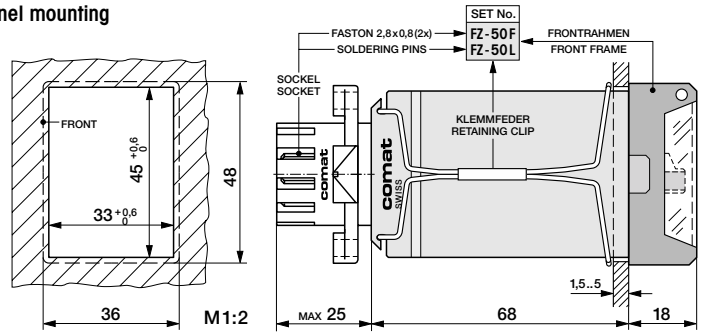

Chassis mounting

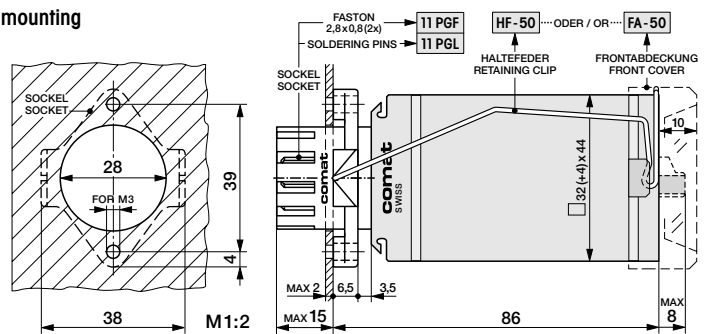

Surface mounting

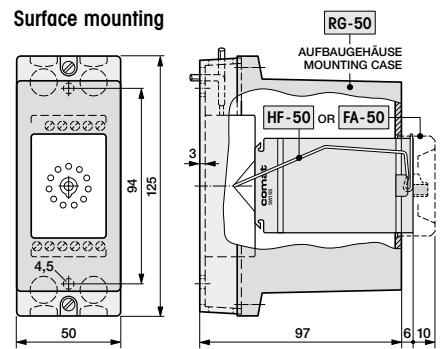

- C11A** Relay socket 11-pole screw terminals 4mm<sup>2</sup>  
with: C-A2 connector (A2-A2) 10A insulated, blue<sup>1)</sup>  
LH-1 Marking labels support for L-16, transparent<sup>1)</sup>  
L-16 Marking strip paper, white<sup>1)</sup>
- 11 PGF** Relay socket 11-pole faston terminals 0,8mm
- 11 PGL** Relay socket 11-pole soldered terminals
- HF-50** Retaining clip<sup>2)</sup> suitable to C11A, 11 PGF, 11 PGL, RG-50
- FZ-...** Front frame set comprises front frame, retaining clip and socket
- FZ-50 F** with faston terminals
- FZ-50 L** with soldered terminals
- FA-50** Front cover with transparent cover<sup>3)</sup>
- RG-50** Mounting case with integrated relay socket
- SP-01..** Remote potentiometer with connection terminals SP-01/100k, SP-01/1M

Remote potentiometer

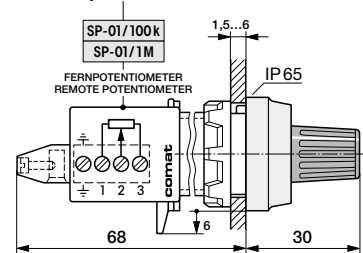

1) Packing units  
2) Not to be used with FA-50  
3) Not to be used with HF-50

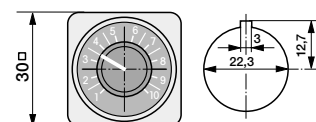

Socket overview

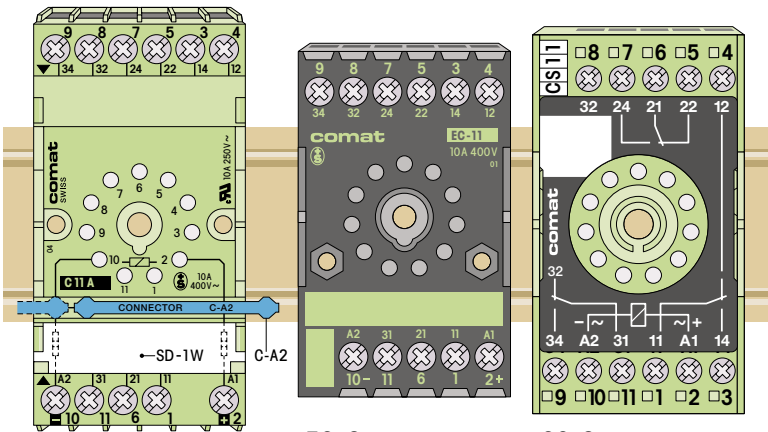

**C11A**  
System socket 11-pole, with white cover and plug-in connector C-A2. (standard delivery).

**EC-8  
EC-11**  
Economy socket 8-/11-pole

**CS-8  
CS-11**  
Economy socket 8-/11-pole

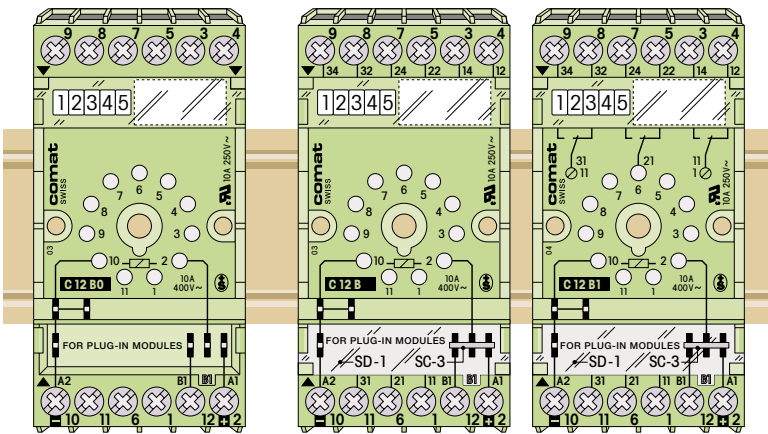

**C12B0**  
System socket 11-pole, similar to C12B. Prepared for CT system (without SC-3, SD-1).

**C12B**  
System socket 11-pole, 12 terminals (+B1). SC-3 inserted for B1-2-A1. Cover transparent.

**C12B1**  
System socket 11-pole, like C12B, but with imprinted contact diagram.

Socket	For type of device			Connection layout
	CT3	CT30	CT2	
C11A	●			A
EC-11	●			A
CS-11	○			B
C12B0		●		A
C12B	○	○		A
C12B1	○	○		A
EC-8			●	
CS-8			○	

● recommended  
○ usable

Connection layout (from left to right side)

